

It all hinges on excellence.

SIMONSWERK

VERTO

The self-closing pivot
hinge system for doors

Content

VERTO – the self-closing pivot hinge system for doors

Double action door

06	VT 101E10	100 kg	Glass doors up to 100 kg for residential, heavy-duty and outer glass doors
07	VT 101E10 SF	100 kg	for residential and heavy-duty glass doors without stop
08	VT 101E10 NF	100 kg	for residential and heavy-duty glass doors without stop
09	VT 100E10 C		for use with VT 100E10
10	VT 100E20	100 kg	for residential and heavy-duty glass doors
11	VT 100E20 C		for use with VT 100E20 and VT 100E25
12	VT 100E25	100 kg	for residential and heavy-duty glass doors
			Residential glass doors up to 80 kg
13	VT 106E10		for residential glass doors
14	VT 106E10 C	80 kg	for VT 106E10
15	VT 106E20/27		for residential glass doors
16	VT 106E20 C	80 kg	for use with VT 106E20/27
17	VT 106E20 C F		for use with VT 106E20/27
			Heavy-duty glass doors up to 150 kg
18	VT 150E00		for heavy-duty and outer glass doors
19	VT 150E10 C	150 kg	for VT 150E00
20	VT 150E30 C		for VT 150E00
21	VT 1027		top pin for VT 100E20
22	VT 8200	150 kg	for heavy-duty and outer glass doors

23 Finishes

25 Service

VERTO – the self-closing pivot hinge system for doors

Pivot hinges for double-action glass doors: VERTO's purist look predestines the hinges for installation in any type of environment with elegance, flexibility and design freedom. At the same time, they support a high-quality architectural concept with the authentic door material glass. The portfolio also includes completely concealed hinges for flush room constructions, for example in shopping centers, office and commercial buildings. The hinges ensure automatic, constant and controlled closing of the door with adjustable speed.

VERTO – the advantages at a glance

- for indoor and outdoor use
- load capacity up to 150 kg
- door width up to 1,200 mm
- hydraulic hinge system
- adjustable closing speed
- constant damping control



Technical efficiency and innovation in an exclusive door hinge system

VERTO is suitable for double-action glass doors. Also for heavy double-action glass doors up to 150 kg with integrated self-closing function it convinces with its elegant, minimalist design. Shock absorbers and extremely strong braking ensure controlled, low-noise operation of the door.

The patented technical concept

The integrated hydraulic damping system allows a smooth and controlled closing process. The doors can be realized with door push handles or with suitable latch lock and counter box. The latch of the lock is quietly and safely pulled into the strike plate which prevents damage to the glass, door hinges and lock, as well as noise pollution. A continuous adjustment on the hinge allows the individual adjustment of the closing speed to any door weight, any door width and the walking speed of the user.

Free choice of colours

VERTO is suitable for coherent concepts in the interior, even on heavy duty doors. The exclusive door hinge system is available in any desirable finish and therefore excellently suited for various application areas.



VERTO

VT 101E10

for double action residential, heavy-duty and outer glass doors up to 100 kg

hydraulic hinge

double action door

Product features

- hydraulic hinge
- for double action outer doors that are protected from severe weather conditions
- integrated brake
- with closing speed adjustment
- with final latch adjustment
- designed for pivoting applications
- stop at +90° and -90°
- automatic closing from +80° and -80°

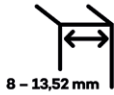
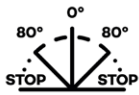

Technical details

load capacity	100.0 kg
rebate depth	30.0–50.0 mm
opening angle	+/- 90°
hold open	+/- 90°
automatic closing	+/- 80°
glass thickness	8–13.52 mm
temperature resistance	- 10.0 °C to + 50.0 °C
max. door width	1000.0 mm

Finish

raw (CO 000)

Combination

VT 100E10 C

Note

i The closing automatism clicks within 70°-80° range. The closing is soft for the first 20° and becomes speed-adjustable from 60° up to complete closing.

Classification key

EN 1154

4	8	3/5*1	0	1	4
---	---	-------	---	---	---

*1 Please refer to the notes and explanations on page 24.

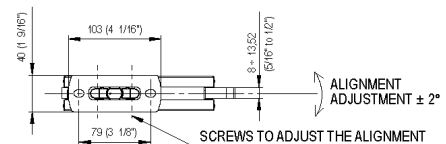
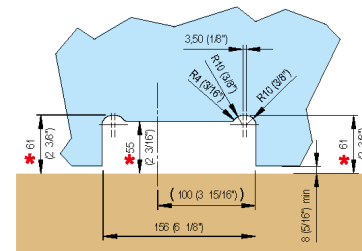
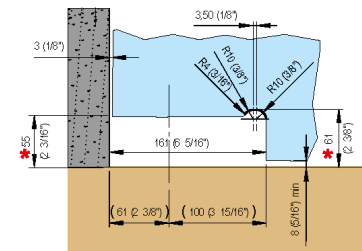
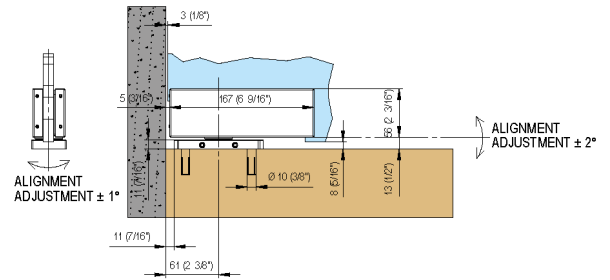



VERTO

VT 101E10 SF

for double action residential and heavy-duty glass doors up to 100 kg without stop

hydraulic hinge | **suitable for doors with stop** | **up to 100 kg**

Product features

- hydraulic hinge
- integrated brake
- with closing speed adjustment
- with final latch adjustment
- designed for pivoting applications
- automatic closing from +80° and -80°

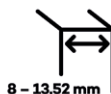

Technical details

load capacity	100.0 kg
opening angle	+/- 90°
glass thickness	8-13.52 mm
temperature resistance	- 10.0 °C to + 50.0 °C
min. door width	1000.0 mm

Finish

raw (CO 000)

Combination

VT 100E10 C

Classification key

EN 1154

4	8	3/5 ^{*1}	0	1	4
---	---	-------------------	---	---	---

*1 Please refer to the notes and explanations on page 24.

VERTO

VT 101E10 NF

for double action residential and heavy-duty glass doors up to 100 kg without brake

hydraulic hinge	double action door	up to 100 kg
-----------------	--------------------	--------------

Product features

- hydraulic hinge
- with closing speed adjustment
- with final latch adjustment
- designed for pivoting applications
- stop at +90° and -90°
- automatic closing from +80° and -80°

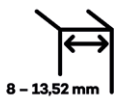
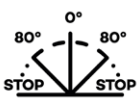

Technical details

load capacity	100.0 kg
opening angle	+/- 90°
hold open	+/- 90°
automatic closing	+/- 80°
glass thickness	8-13.52 mm
temperature resistance	- 10.0 °C to + 50.0 °C
min. door width	1000.0 mm

Finish

raw (CO 000)

Combination

VT 100E10 C

Note

i The self-closing function works from a range of 70° - 80° open position of the door. The closing is soft for the first 20° and becomes speed-adjustable from 60° up to complete closing.

Classification key

EN 1154

4	8	3/5*1	0	1	4
---	---	-------	---	---	---

*1 Please refer to the notes and explanations on page 24.

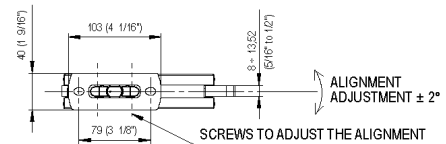
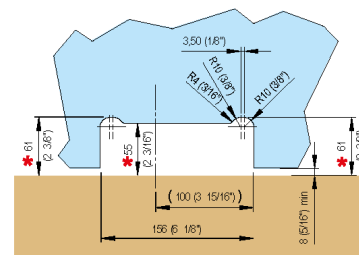
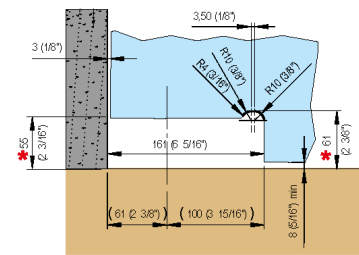
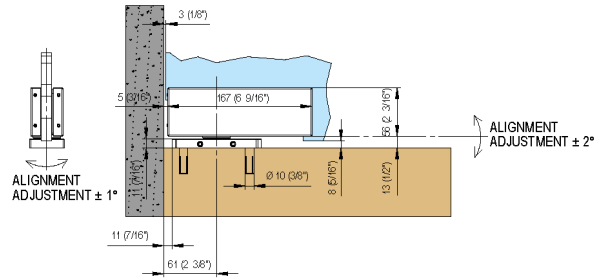

VERTO



VT 100E10 C

for use with VT 100E10

cover

Finish

EV1 satin silver natural, anodized 20 micron (CO 002), satin black, anodized (CO 005), polished chromed (CO 014), matt gray, liquid electrostatic coated (CO 015), similar polished gold, PVD coated (CO 016), similar matt gold, coated (CO 017), brushed stainless steel (CO 031), polished stainless steel (CO 032), RAL 9005 jet black matt, liquid electrostatic coated (CO 062), RAL 9010 pure white matt, liquid electrostatic coated (CO 088), RAL 9016 traffic white matt, liquid electrostatic coated (CO 095)

Combination

VT 101E10, VT101E10 NF, VT 101E10 SF

VERTO

VT 100E20

for double action residential and heavy-duty glass doors up to 100 kg

hydraulic hinge double action door up to 100 kg

Product features

- top hinge
- free swinging hinge

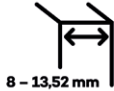
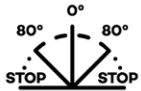

Technical details

load capacity	100.0 kg
glass thickness	8-13.52 mm
max. door width	1000.0 mm

Finish

raw (CO 000)

Combination

VT 100E20 C, VT 100E25, VT 1027

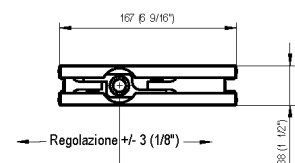
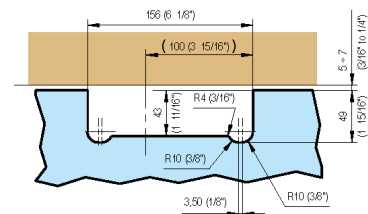
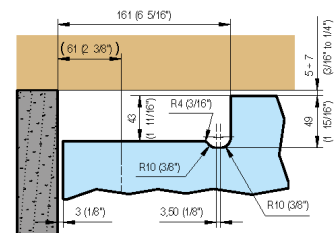
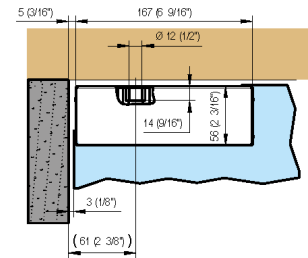

VERTO

VT 100E20 C

for use with VT 100E20 and VT 100E25

cover**Finish**

EV1 satin silver natural, anodized 20 micron (CO 002), satin black, anodized (CO 005), polished chromed (CO 014), matt gray, liquid electrostatic coated (CO 015), similar polished gold, PVD coated (CO 016), similar matt gold, coated (CO 017), brushed stainless steel (CO 031), polished stainless steel (CO 032), RAL 9005 jet black matt, liquid electrostatic coated (CO 062), RAL 9010 pure white matt, liquid electrostatic coated (CO 088), RAL 9016 traffic white matt, liquid electrostatic coated (CO 095)

Combination

VT 100E20, VT 100E25



VERTO

VT 100E25

for double action residential and heavy-duty glass doors up to 100 kg

hydraulic hinge	double action door	up to 100 kg
-----------------	--------------------	--------------

Product features

- transom link
- to be matched with VT 100E20

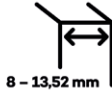
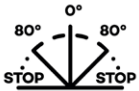

Technical details

load capacity	100.0 kg
glass thickness	8-13.52 mm
max. door width	1000.0 mm

Finish

raw (CO 000)

Combination

VT 100E20 , VT 100E20 C

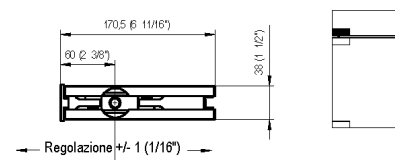
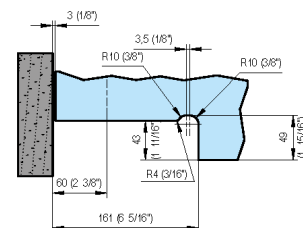
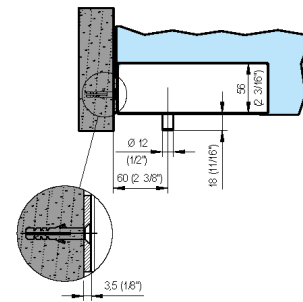
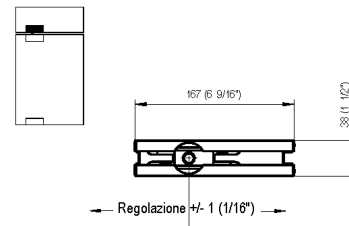
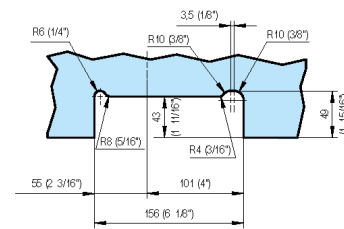
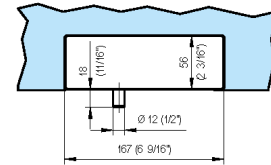

VERTO

VT 106E10

for double action residential glass doors up to 80 kg



hydraulic hinge	double action door	up to 80 kg
-----------------	--------------------	-------------

Product features

- hydraulic hinge
- with predetermined, non-modifiable automatic closing
- stop at +90° and -90°
- automatic closing from +80° and -80°
- can also be used for single action doors
- combining the bottom hinge with a top hinge allows the reduction of the closing speed

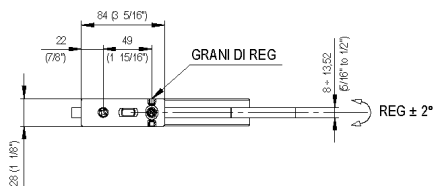
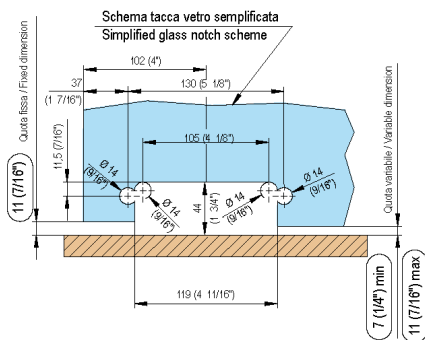
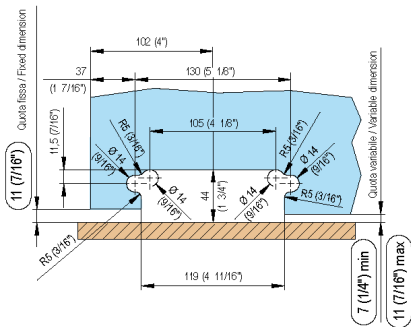
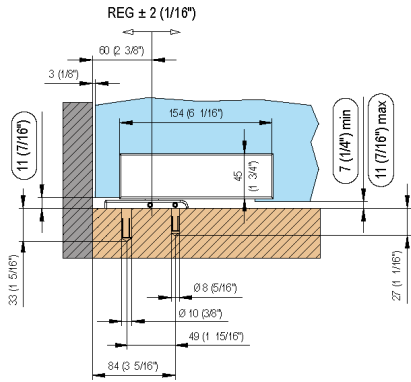

Technical details

load capacity	80.0 kg
opening angle	+/- 90°
hold open	+/- 90°
automatic closing	+/- 80°
glass thickness	8–13.52 mm
temperature resistance	- 5.0 °C to + 40.0 °C
min. door width	800.0 mm
max. door width	1000.0 mm

Finish

raw (CO 000)

Combination

VT 106E10 C, VT 106E20/27

Note

i To be combined with magnetic locks only.

VERTO

VT 106E10 C

for VT 106E10



cover

Finish

brushed stainless steel (CO 031), polished stainless steel (CO 032), RAL 9005 jet black matt, liquid electrostatic coated (CO 062), RAL 9010 pure white matt, liquid electrostatic coated (CO 088), RAL 9016 traffic white matt, liquid electrostatic coated (CO 095)

Combination

VT 106E10

VERTO

VT 106E20/27

for double action residential glass doors up to 80 kg



hydraulic hinge	double action door	up to 80 kg
-----------------	--------------------	-------------

Product features

- upper hinge with pivot
- to be matched with VT 106E10
- integrated brake



Technical details

load capacity	80.0 kg
glass thickness	8-13.52 mm
max. door width	1000.0 mm

Finish

raw (CO 000)

Combination

VT 106E20 C, VT 106E10

Note

i To be combined with magnetic locks only.

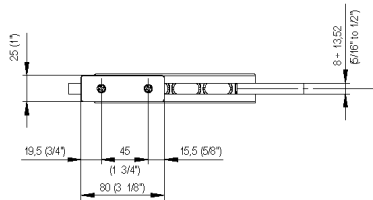
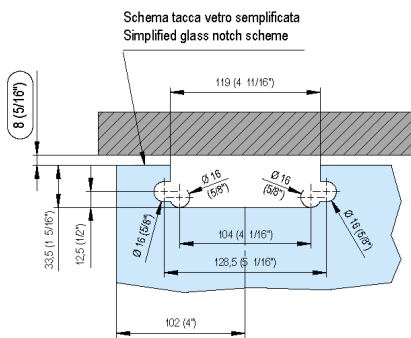
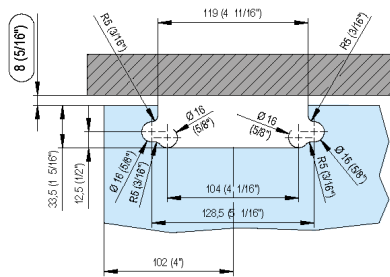
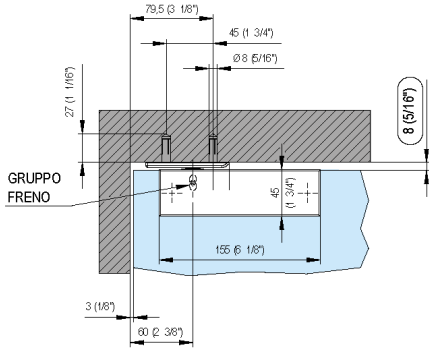

VERTO

VT 106E20 C

for use with VT 106E20/27

cover

Finish

brushed stainless steel (CO 031), polished stainless steel (CO 032), RAL 9005 jet black matt, liquid electrostatic coated (CO 062), RAL 9010 pure white matt, liquid electrostatic coated (CO 088), RAL 9016 traffic white matt, liquid electrostatic coated (CO 095)

Combination

VT 106E20/27



VERTO



VT 106E20 C F

for use with VT 106E20/27

cover

Finish

RAL 9005 jet black matt, liquid electrostatic coated (CO 062), RAL 9010 pure white matt, liquid electrostatic coated (CO 088), RAL 9016 traffic white matt, liquid electrostatic coated (CO 095)

VERTO

VT 150E00

for double action heavy-duty and outer glass doors up to 150 kg

hydraulic hinge	double action door	up to 150 kg
-----------------	--------------------	--------------

Product features

- hydraulic top and bottom hinge
- bodies only
- integrated brake
- with closing speed adjustment
- with final latch adjustment
- stop at +90° and -90°
- automatic closing from +80° and -80°

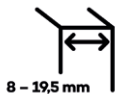
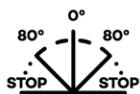

Technical details

load capacity	150.0 kg
opening angle	+/- 90°
hold open	+/- 90°
automatic closing	+/- 80°
glass thickness	8-19.05 mm
temperature resistance	- 10.0 °C to + 50.0 °C
max. door width	1200.0 mm

Finish

raw (CO 000)

Combination

VT 150E10 C, VT 150E30 C

Note

i For installations in particular environments or climate (ex. Wet, acid, saline) consult sales office first.

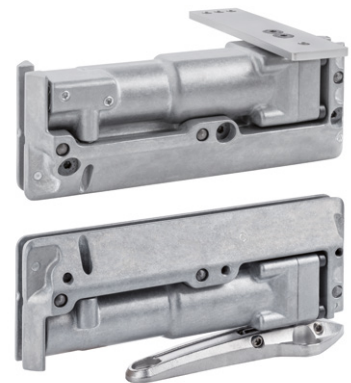

Bottom hinge

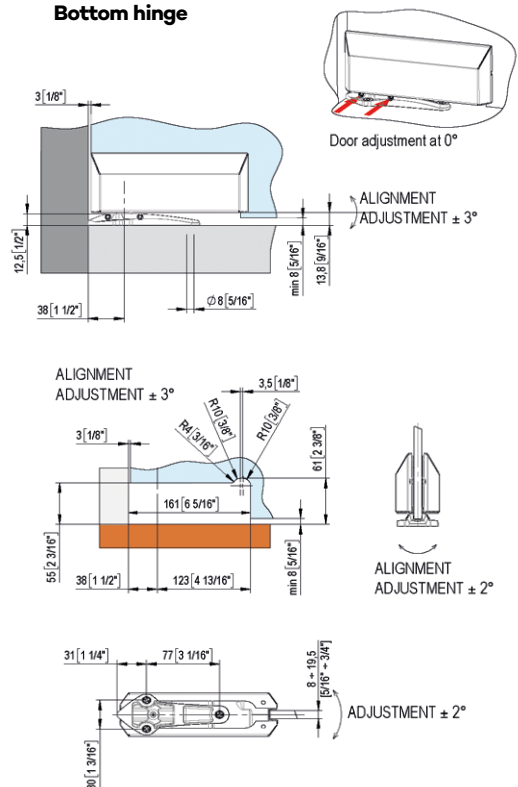

Top hinge

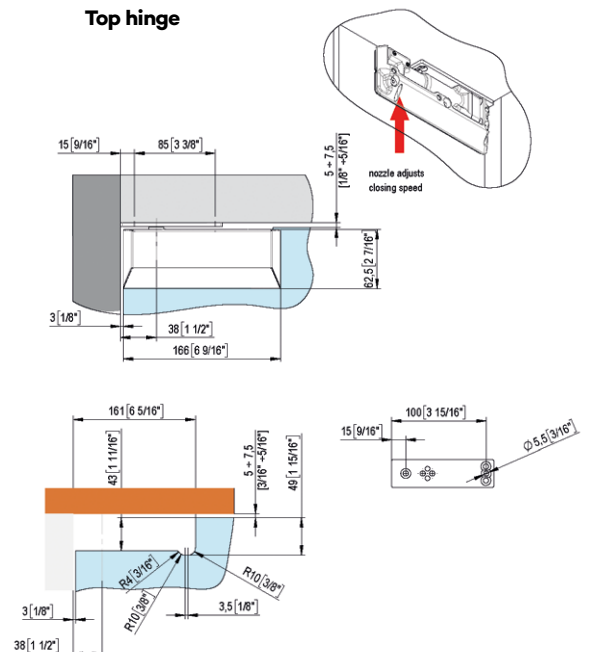

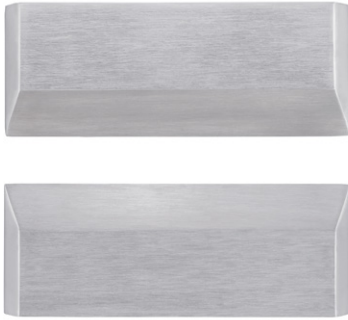

VERTO

VT 150E10 C

for VT 150E00

cover

Product features

- set of shaped covers
 - for inner and outer doors
-

Finish

brushed stainless steel (CO 031), polished stainless steel (CO 032), RAL 9005 jet black matt, liquid electrostatic coated (CO 062), RAL 9010 pure white matt, liquid electrostatic coated (CO 088), RAL 9016 traffic white matt, liquid electrostatic coated (CO 095)

Combination

VT 150E00

VERTO

VT 150E30 C

for VT 150E00

cover

Product features

- set of squared covers
 - for inner and outer doors
-

Finish

brushed stainless steel (CO 031), polished stainless steel (CO 032), RAL 9005 jet black matt, liquid electrostatic coated (CO 062), RAL 9010 pure white matt, liquid electrostatic coated (CO 088), RAL 9016 traffic white matt, liquid electrostatic coated (CO 095)

Combination

VT 150E00



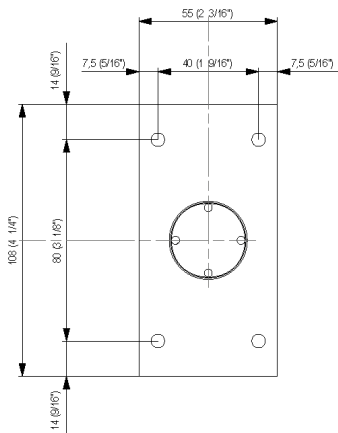
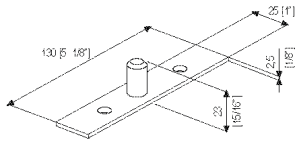

VERTO

VT 1027

top pin for VT 100E20

accessories

Finish

brushed stainless steel (CO 031), RAL 9005 matt liquid electrostatic coated (CO 062), RAL 9010 pure white matt, liquid electrostatic coated (CO 088), RAL 9016 traffic white matt, liquid electrostatic coated (CO 095)

Combination

VT 100E20

Note

i For installations in particular environments or climate (ex. Wet, acid, saline) consult sales office first.

VERTO

VT 8200

for double action heavy-duty and outer glass doors up to 150 kg

hydraulic hinge	double action door	up to 150 kg
-----------------	--------------------	--------------

Product features

- hydraulic top and bottom hinge
- integrated brake
- with closing speed adjustment
- with final latch adjustment
- stop at +90° and -90°
- automatic closing from +80° and -80°

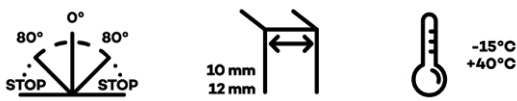

Technical details

load capacity	150.0 kg
opening angle	+/- 90°
hold open	+/- 90°
automatic closing	+/- 80°
glass thickness	10 mm / 12 mm
temperature resistance	- 15.0 °C to + 40.0 °C
max. door width	1200.0 mm

Finish

EV1 satin silver natural, anodized 20 micron (CO 002), satin black, anodized (CO 005), similar satin stainless steel, PVD coated (CO 013), polished chromed (CO 014), RAL 9005 jet black matt, liquid electrostatic coated (CO 062), RAL 9010 pure white matt, liquid electrostatic coated (CO 088), RAL 9016 traffic white matt, liquid electrostatic coated (CO 095)

Note

i For installations in particular environments or climate (ex. Wet, acid, saline) consult sales office first. Violent opening further than 95° could unhinge the door. We suggest to install a door stop.

Classification key

EN 1154

4	8	3/5*1	0	1	4
---	---	-------	---	---	---

*1 Please refer to the notes and explanations on page 24.



Bottom hinge

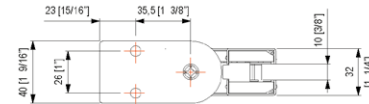
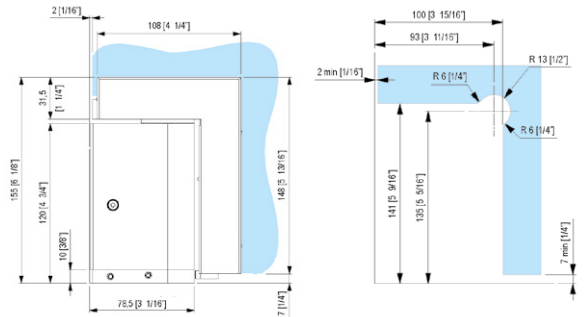

Top hinge

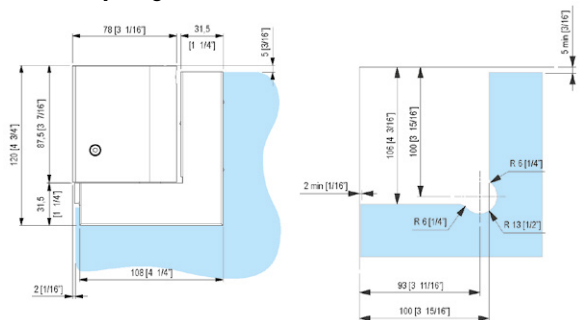

Finishes

Standard finishes



EV1 satin silver natural, anodized 20 micron (CO 002)



Satin black anodized (CO 005)



Imitation satin stainless steel (CO 013)



polished Chrome (CO 014)



Imitation matt chrome liquid electrostatic coated (CO 015)



polished gold (CO 016)

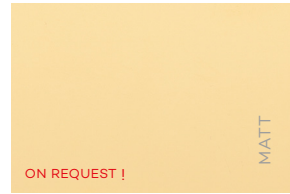

matt gold (CO 017)



Brushed stainless steel (CO 031)



Polished stainless steel (CO 032)

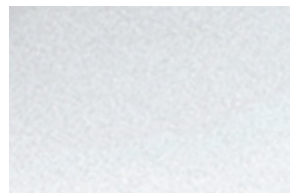

Polished (CO 047)

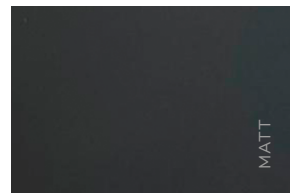

RAL 9005 matt liquid electrostatic coated (CO 062)

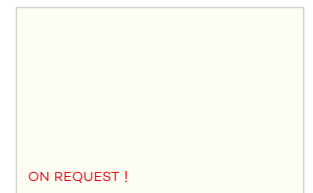

RAL 9005 matt liquid electrostatic coated (CO 088)

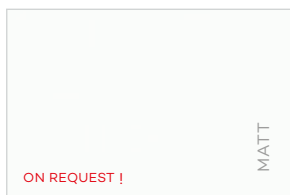

RAL 9016 matt liquid electrostatic coated (CO 095)



COL02 | Finish Folder

Special finishes

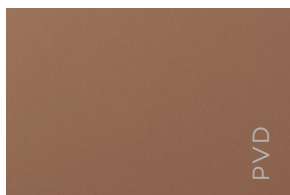

Polished bright bronze (CO 066)

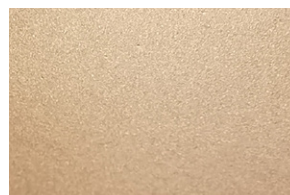

Satin mat bronze (CO 067)

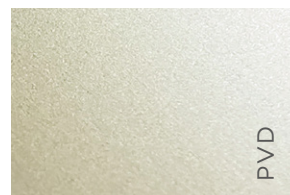

Polished bright champagne (CO 068)

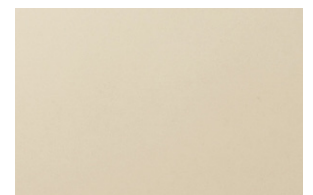

Satin mat champagne (CO 069)

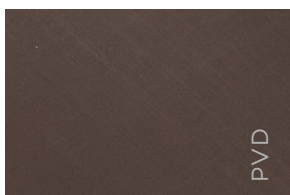

Polished bright gunmetal grey (CO 070)

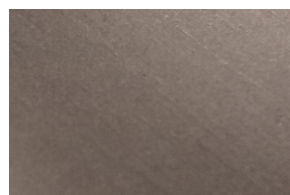

Satin mat gunmetal grey (CO 071)

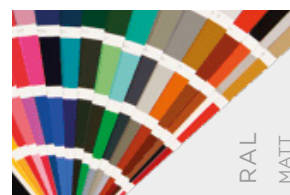

RAL | Liquid electrostatic coated



COL03 | Special Finish Folder

PVD – Physical Vapour Deposition

Metal coating that ensures: exceptional resistance to abrasion, resistance to oxidation, innovative and durable colouring.

Ask our sales dept for minimum order, for a quotation and delivery time.

Explanations

General explanations on the classification key used in accordance with EN 1154:2006 for door closing devices with controlled closing sequence:

Our self-closing hinge systems are tested and certified in accordance with the EN 1154:2006 standard. As the European standard does not cover all products available on the market for closing doors with a controlled closing sequence, the European standard is not applicable in all respects to self-closing door hinges. Due to their small size, the torques to be achieved deviate from EN 1154:2006 depending on the door dimensions. The third digit of the certification key is therefore split:

The front digit indicates the torques achieved and the efficiency in accordance with EN 1154:2006, the rear digit indicates the maximum door weight in accordance with EN 1154:2006. All other technical characteristics are specified in the technical data sheets.

The closing forces can be influenced by the type of application design by using one to three door hinges with hydraulic closing function per door and eventually add door hinges without hydraulic closing function.

Service – comprehensive expertise for your daily work

We are happy to provide you with all the documentation you need to determine the most suitable hinge system for your building project. Please contact us: we would be delighted to work with you to choose the best solution – from high-quality standard elements right up to the most complex solutions.

All our brochures and data sheets can be requested in a printed version, or you can simply download them on the spot.

Our friendly and knowledgeable application engineers will be pleased to help you and advise you.

www.simonswerk.com

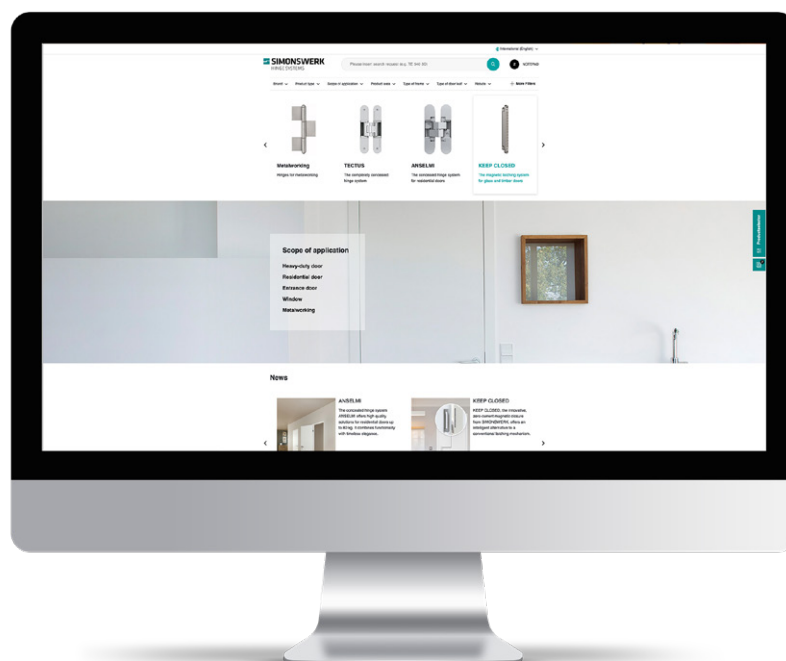

SIMONSWERK GROUP – excellence in product and service

As an internationally operating group of companies, the SIMONSWERK GROUP is the market leader in the area of high-quality hinge systems. With over 900 employees worldwide, we stand for the highest quality standards, constant willingness to innovate and long-lasting customer relationships.

The SIMONSWERK brand combines the entire expertise in hinge systems and unites technical know-how with design standards at the highest level. In addition to innovative product solutions, we offer our customers the best service exactly where it is needed. From personal customer consultations and competent training courses to customised delivery and logistics processes or digital service tools.

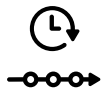

Over 130 years of experience

The perfect foundation for continuous growth with experience



Internationally successful

As the market leader, we are constantly expanding our know-how



Over 900 employees worldwide

Every single employee shapes the vision of the SIMONSWERK GROUP



Focused product solutions

With high-quality hinge systems for heavy-duty, residential and entrance doors, we offer product solutions for all applications and materials

For our customers and partners

As SIMONSWERK GROUP, we are active in a variety of business models. Both in the construction project business and in cooperation with door manufacturers as well as with hardware dealers and processors, we develop perfect solutions, depending on individual market needs. We will provide our customers and decision-makers with the best possible support as a partner in accordance with their various requirements.



SIMONSWERK

VERTO

The self-closing pivot hinge system for doors

SIMONSWERK GmbH

Bosfelder Weg 5
33378 Rheda-Wiedenbrück
Germany

+49 5242 4130

info@simonswerk.de

www.simonswerk.de

Member of the

**SIMONSWERK
GROUP**

© SIMONSWERK GmbH
01/2024, 5 8006070 00001/20
Subject to technical modifications.

